

SPECIFICATION

Device Name : I G B T M o d u l e

Type Name : 6 M B I 7 5 S - 1 4 0

Spec. No. : M S 5 F 4 7 2 4

Fuji Electric Co., Ltd.
Matsumoto Factory

	DATE	NAME	APPROVED	Fuji Electric Co., Ltd.		
DRAWN	Nov. - 10 - '99	<i>Y. Hologuchi</i>	<i>T. Nishizaka</i>	DWG. NO.	M S 5 F 4 7 2 4	1 / 8
CHECKED	Nov. - 10 - '99	<i>S. Mita</i>				

This material and the information herein is the property of Fuji Electric Co., Ltd. They shall be neither reproduced, copied, lent, or disclosed in any way whatsoever for the use of any third party nor used for the manufacturing purposes without the express written consent of Fuji Electric Co., Ltd.

Revised Records

Date	Classi- fication	Ind.	Content	Applied date	Drawn	Checked	Approved
Nov. - 16 - 49	enactment	—	—————	Issued date	—	S. M. H. a	T. Miyasaka

This material and the information herein is the property of Fuji Electric Co., Ltd. They shall be neither reproduced, copied, lent, or disclosed in any way whatsoever for the use of any third party nor used for the manufacturing purposes without the express written consent of Fuji Electric Co., Ltd.

Fuji Electric Co., Ltd.

DWG. NO.	MS 5 F 4 7 2 4	2 / 8				
----------	----------------	-------	--	--	--	--

6 M B I 7 5 S - 1 4 0

1. Outline Drawing (Unit : mm)

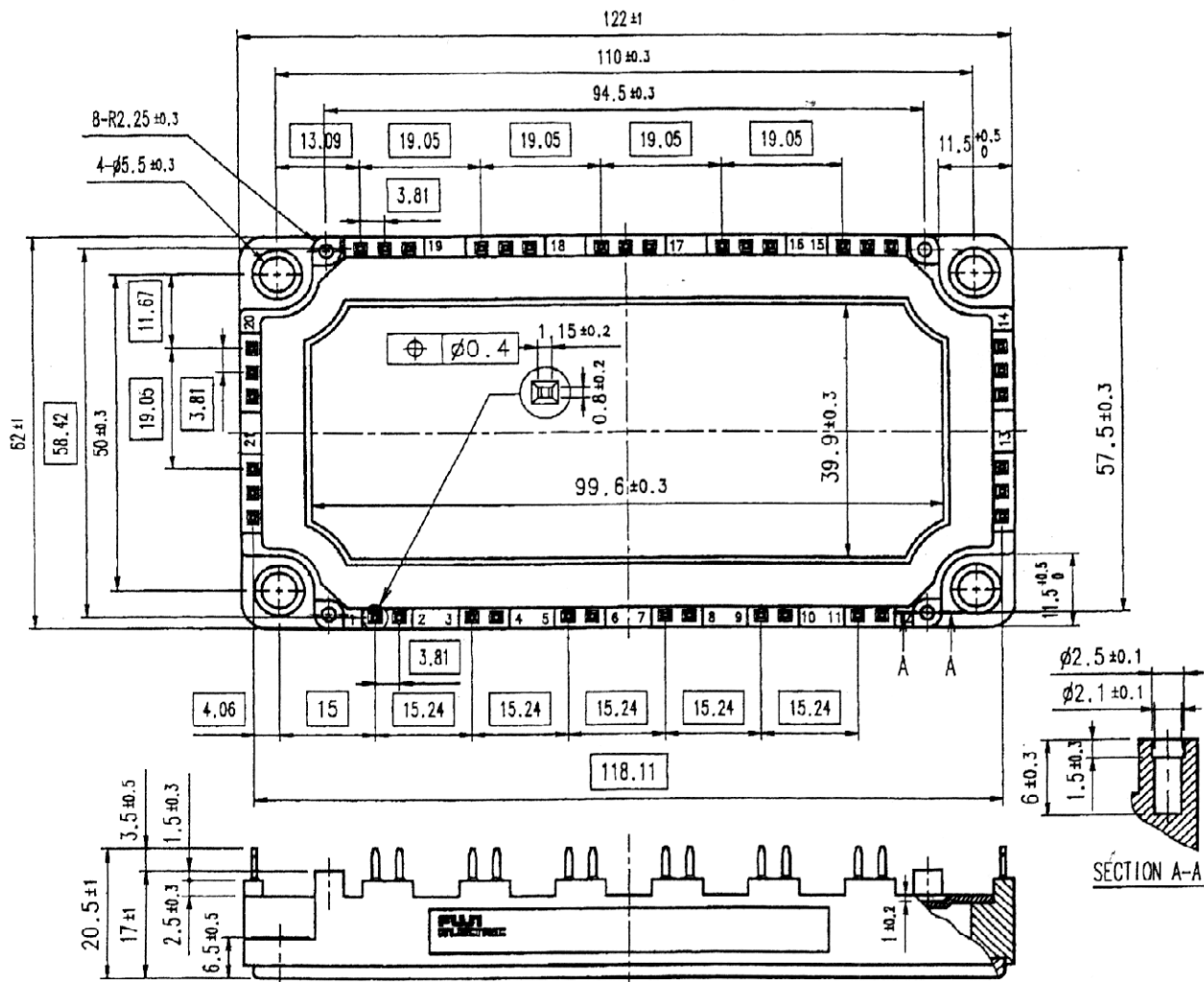

2. Equivalent circuit

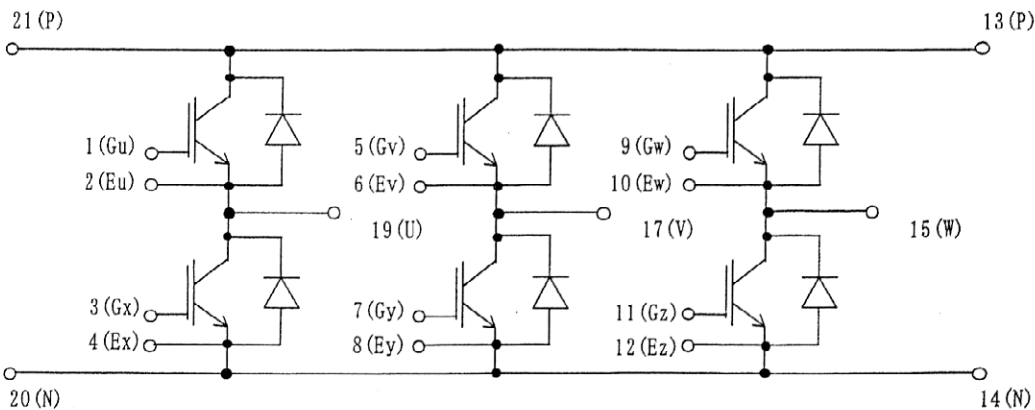

This material and the information herein is the property of Fuji Electric Co., Ltd. They shall be neither reproduced, copied, lent, or disclosed in any way whatsoever for the use of any third party, nor used for the manufacturing purposes without the express written consent of Fuji Electric Co., Ltd.

3. Absolute Maximum Ratings (at Tc= 25°C unless otherwise specified)

Items	Symbols	Conditions	Maximum Ratings		Units
Collector-Emitter voltage	V _{CES}		1400		V
Gate-Emitter voltage	V _{GES}		±20		V
Collector current	I _c	Continuous	Tc=25°C	100	A
			Tc=75°C	75	
	I _c pulse	1ms	Tc=25°C	200	
			Tc=75°C	150	
	-I _c			75	
-I _c pulse		1ms	150		
Collector Power Dissipation	P _c	1 device	520		W
Junction temperature	T _j		150		°C
Storage temperature	T _{stg}		-40~ +125		°C
Isolation voltage ^(*)	Viso	AC : 1min.	2500		V
Mounting Screw Torque ^(*)			3.5		N·m

(*1) All terminals should be connected together when isolation test will be done.

(*2) Recommendable Value : 2.5~3.5 N·m (M5)

4. Electrical characteristics (at Tj= 25°C unless otherwise specified)

Items	Symbols	Conditions	Characteristics			Units
			min.	typ.	Max.	
Zero gate voltage Collector current	ICES	V _{GE} = 0 V, V _{CES} = 1400 V			1.0	mA
Gate-Emitter leakage current	IGES	V _{CES} = 0 V, V _{GE} = ±20 V			200	nA
Gate-Emitter threshold voltage	V _{GE(th)}	V _{CES} = 20 V, I _c = 75 mA	5.5	7.2	8.5	V
Collector-Emitter saturation voltage	V _{CES(sat)}	V _{GE} = 15 V, T _j = 25 °C		2.4	2.7	V
		I _c = 75 A, T _j = 125 °C		3.0		
Input capacitance	C _{ies}	V _{GE} = 0 V		9000		pF
Output capacitance	C _{oes}	V _{CES} = 10 V		1875		
Reverse transfer capacitance	C _{res}	f = 1 MHz		1650		
Turn-on time	t _{on}	V _{CC} = 800 V		0.35	1.2	μs
	t _r	I _c = 75 A		0.25	0.6	
	t _{r(i)}	V _{GE} = ±15 V		0.1		
Turn-off time	t _{off}	R _G = 16 Ω		0.45	1.0	μs
	t _f			0.08	0.3	
Forward on voltage	V _F	I _F = 75 A, T _j = 25 °C		2.6	3.4	V
		T _j = 125 °C		2.2		
Reverse recovery time	t _{rr}	I _F = 75 A			0.35	μs

5. Thermal resistance characteristics

Items	Symbols	Conditions	Characteristics			Units
			min.	typ.	Max.	
Thermal resistance (1 device)	R _{th(j-c)}	IGBT			0.24	°C/W
		FWD			0.50	
Contact Thermal resistance	R _{th(c-f)}	with Thermal Compound ^(*)		0.05		

* This is the value which is defined mounting on the additional cooling fin with thermal compound.

Fuji Electric Co.,Ltd.

DWG.NO.

MS5F 4724

4/8

6. Indication on module (モジュール表示)

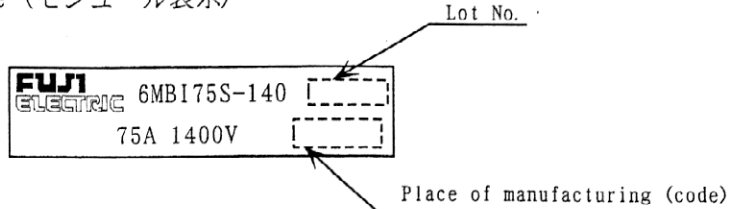

7. Applicable category (適用範囲)

This specification is applied to IGBT Module named 6MBI75S-140 .
 本納入仕様書は IGBTモジュール 6MBI75S-140 に適用する。

8. Storage and transportation notes (保管・運搬上の注意事項)

- The module should be stored at a standard temperature of 5 to 35°C and humidity of 45 to 75% .
 常温・常湿保存が望ましい。(5~35°C, 45~75%)
- Store modules in a place with few temperature changes in order to avoid condensation on the module surface.
 急激な温度変化のなきこと。(モジュール表面が結露しないこと)
- Avoid exposure to corrosive gases and dust.
 腐蝕性ガスの発生場所, 塵埃の多い場所は避けること。
- Avoid excessive external force on the module.
 製品に荷重がかからないように 十分注意すること。
- Store modules with unprocessed terminals.
 モジュールの端子は未加工の状態 で保管すること。
- Do not drop or otherwise shock the modules when transporting.
 製品の運搬時に衝撃を与えたり, 落下させたりしないこと。

9. Definitions of switching time (スイッチング時間の定義)

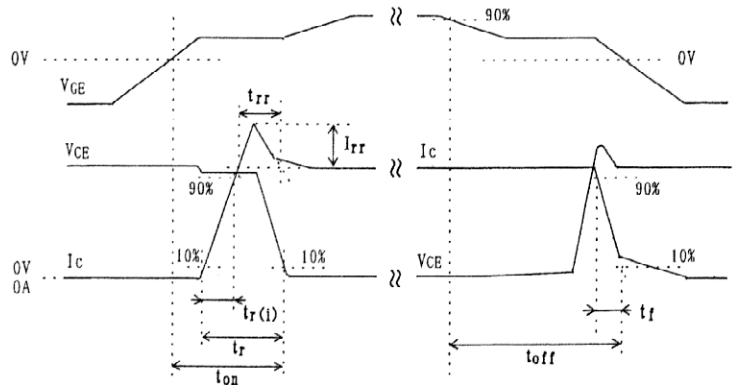
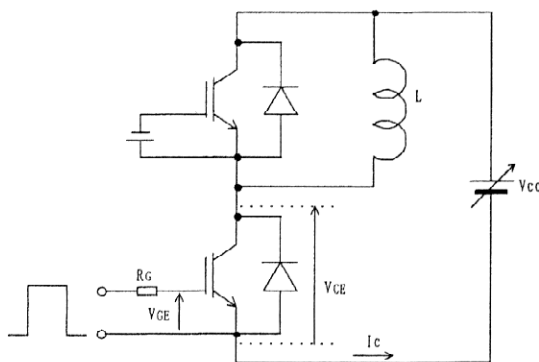

This material and the information herein is the property of Fuji Electric Co. Ltd. They shall be neither reproduced, copied, lent, or disclosed in any way whatsoever for the use of any third party, nor used for the manufacturing purposes without the express written consent of Fuji Electric Co., Ltd.

This material and the information herein is the property of Fuji Electric Co., Ltd. They shall be neither reproduced, copied, lent, or disclosed in any way whatsoever for the use of any third party nor used for the manufacturing purposes without the express written consent of Fuji Electric Co., Ltd.

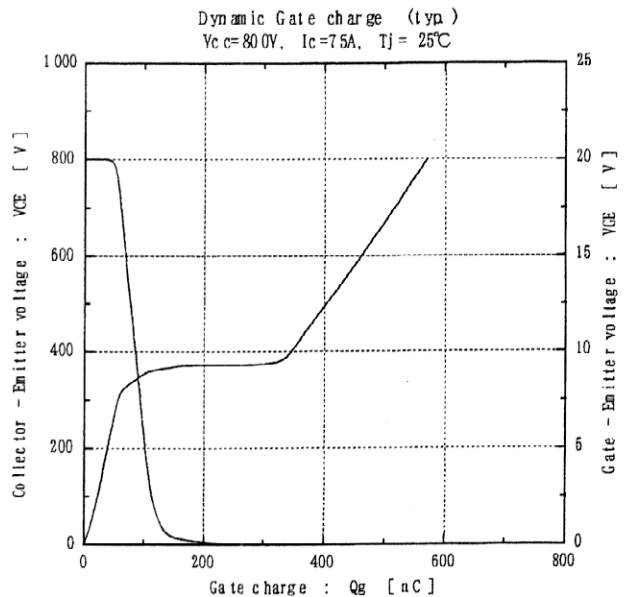
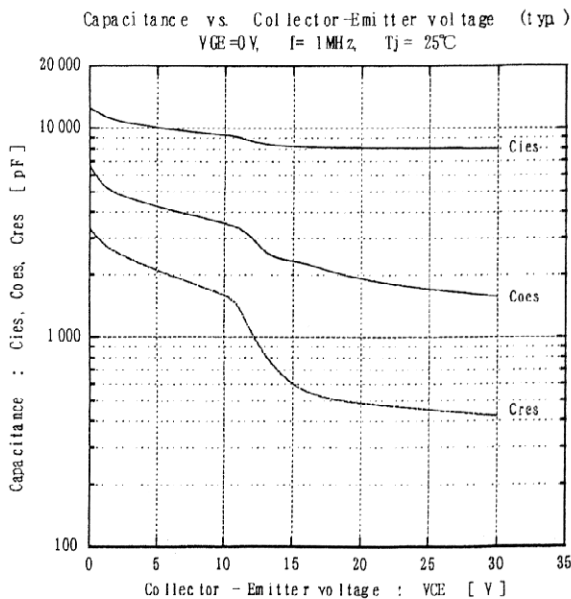
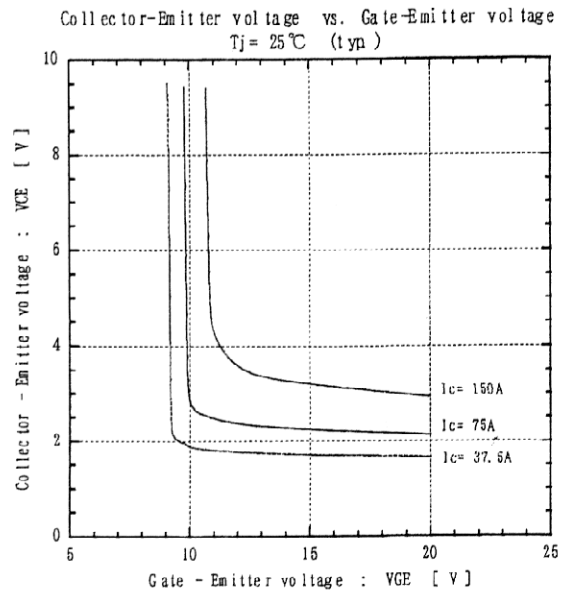
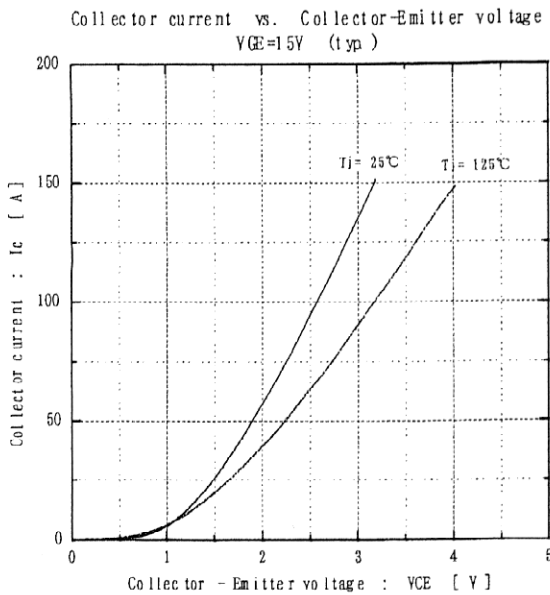
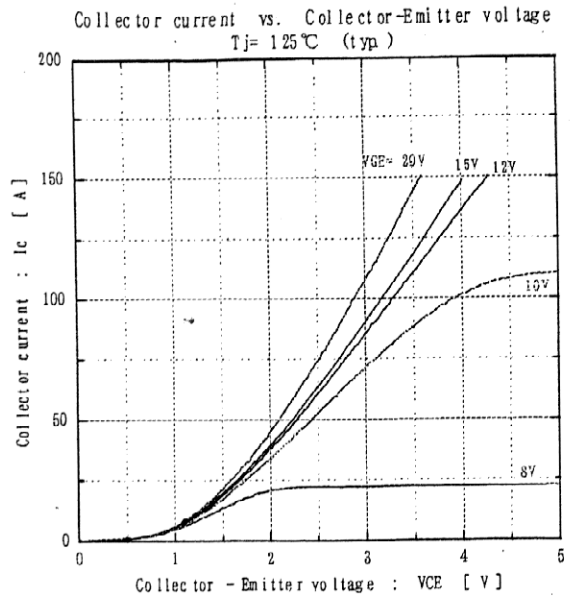
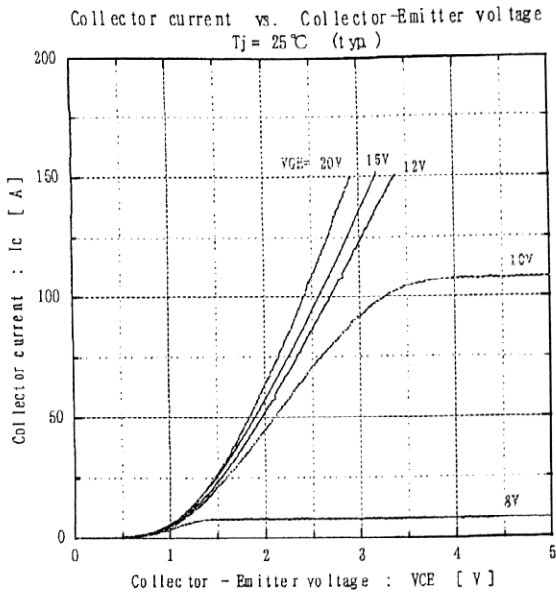

Fuji Electric Co., Ltd.

DWG. NO.

MS5F4724

6/8

H04-004-03

This material and the information herein is the property of Fuji Electric Co. Ltd. They shall be neither reproduced, copied, lent, or disclosed in any way whatsoever for the use of any third party nor used for the manufacturing purposes without the express written consent of Fuji Electric Co., Ltd.

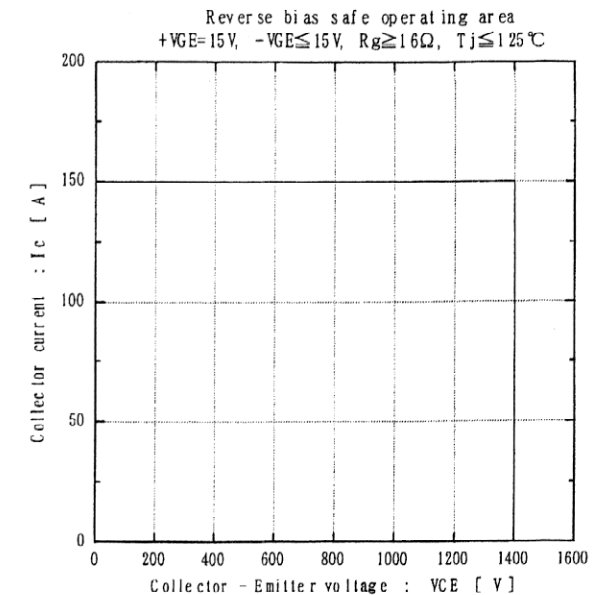
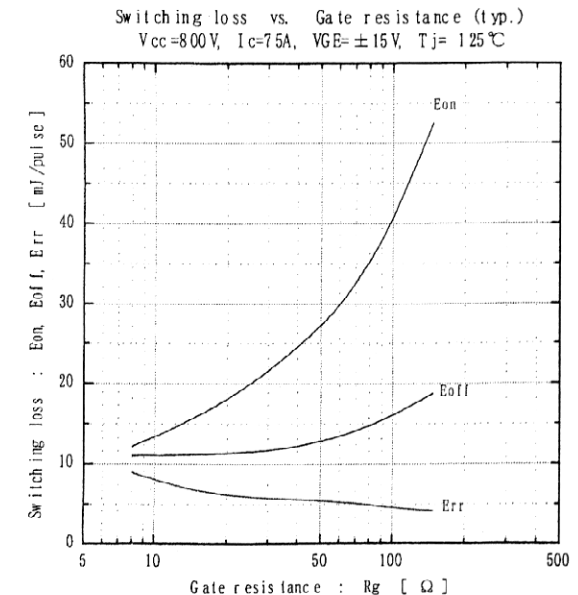
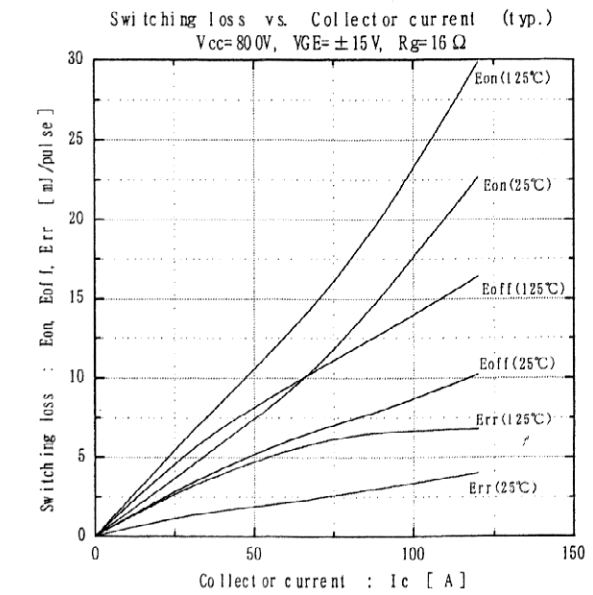
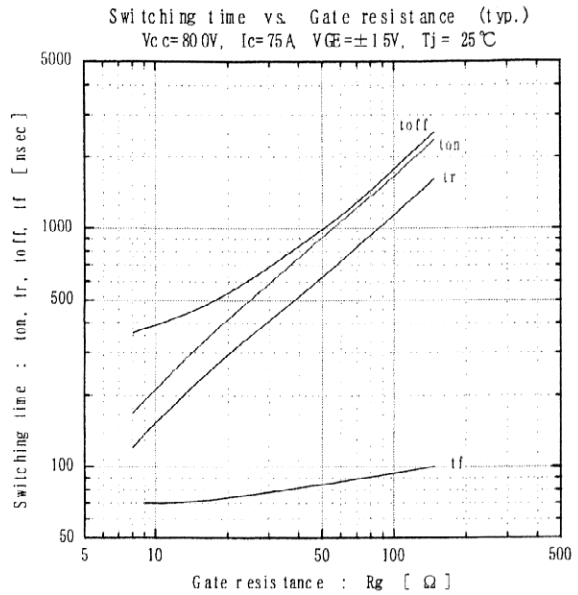
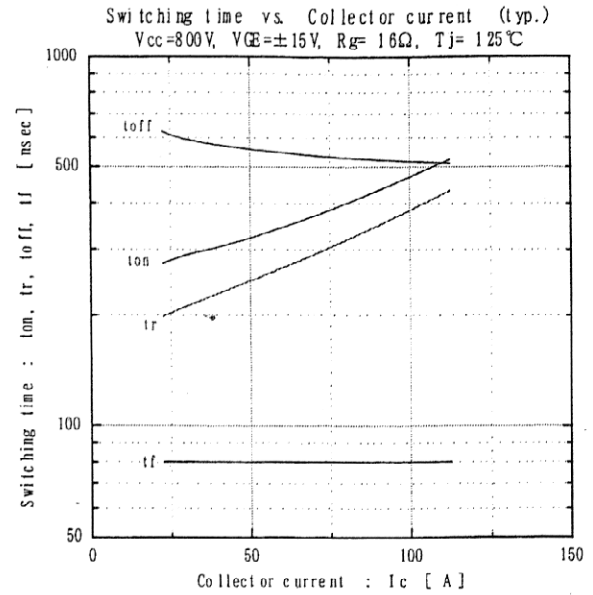
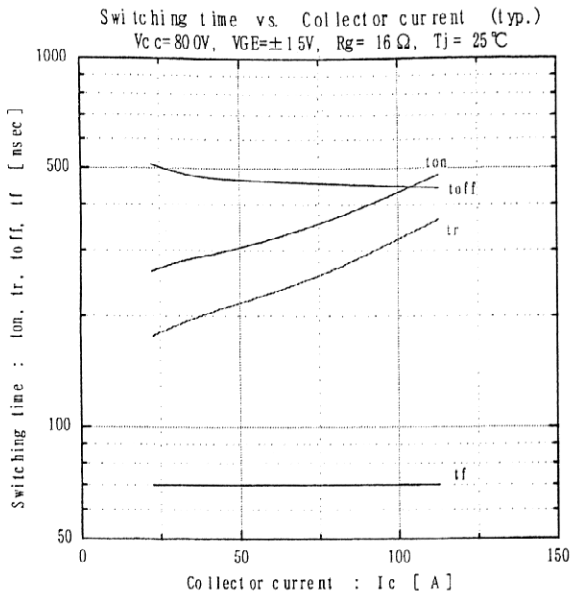

Fuji Electric Co., Ltd.

DWG. NO.

MS5F 4724

7/8

Forward current vs. Forward on voltage (typ.)

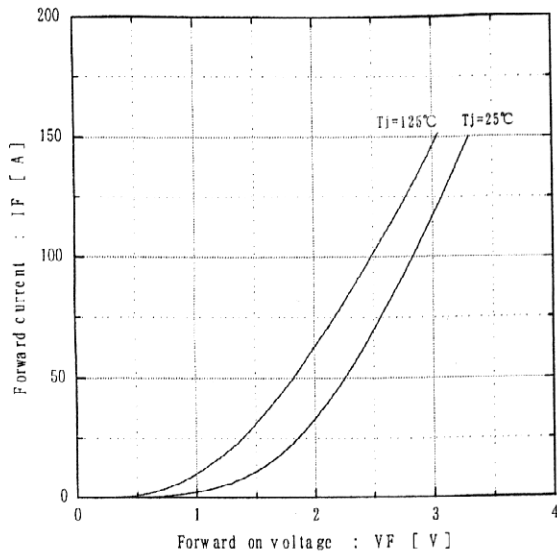

Reverse recovery characteristics (typ.)
Vc=80.0V, VGE=±15V, Rg=16Ω

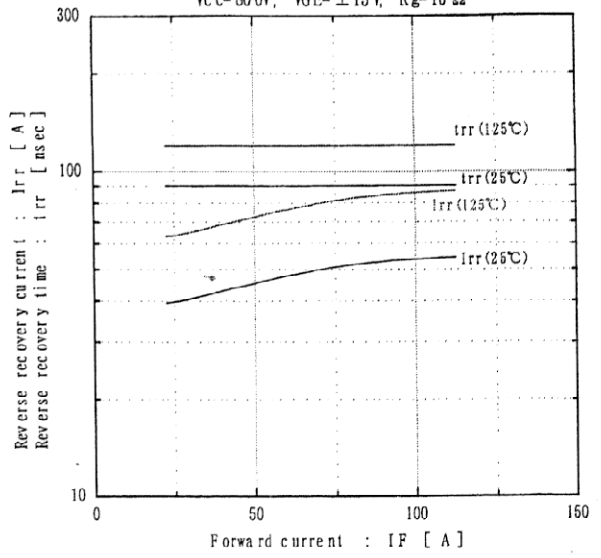

Transient thermal resistance

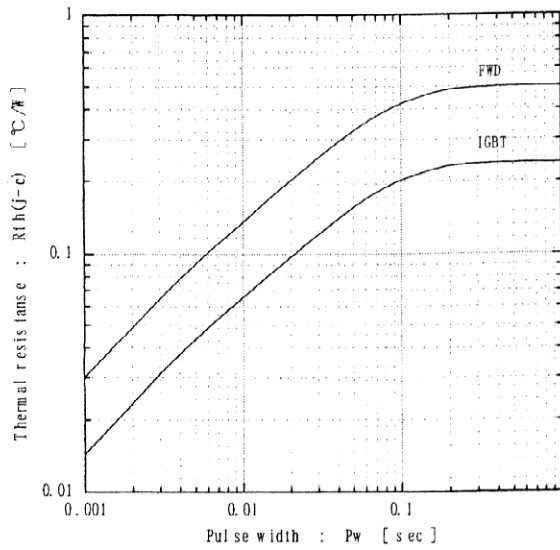

This material and the information herein is the property of Fuji Electric Co. Ltd. They shall be neither reproduced, copied, lent, or disclosed in any way whatsoever for the use of any third party nor used for the manufacturing purposes without the express written consent of Fuji Electric Co., Ltd.

Fuji Electric Co., Ltd.

DWG. NO.

MS5F 4724

8/8